

Induction Hob, Wok and Griddle

LIBERO LINE

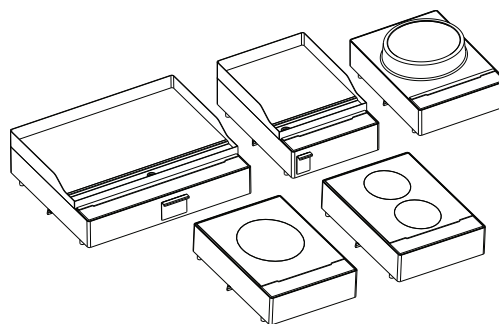

EN Installation and operating manual *



Foreword

 Read the following instructions, including the warranty terms before installing and using the appliance.

Visit our website www.electroluxprofessional.com and open the Support section to:

 Register your product

 Get hints & tips of your product, service and repair information

The installation, use and maintenance manual (hereinafter Manual) provides the user with information necessary for correct and safe use of the appliance.

The following must not be considered a long and exacting list of warnings, but rather a set of instructions suitable for improving appliance performance in every respect and, above all, preventing injury to persons and animals and damage to property due to improper operating procedures.

All persons involved in appliance transport, installation, commissioning, use and maintenance, repair and disassembly must consult and carefully read this manual before carrying out the various operations, in order to avoid wrong and improper actions that could compromise the appliance's integrity or endanger people. Make sure to periodically inform the user regarding the safety regulations. It is also important to instruct and update personnel authorised to operate on the appliance, regarding its use and maintenance.

The manual must be available to operators and carefully kept in the place where the appliance is used, so that it is always at hand for consultation in case of doubts or whenever required.

If, after reading this manual, there are still doubts regarding appliance use, do not hesitate to contact the Manufacturer or the authorised Service Centre to receive prompt and precise assistance for better operation and maximum efficiency of the appliance. During all stages of appliance use, always respect the current regulations on safety, work hygiene and environmental protection. It is the user's responsibility to make sure the appliance is started and operated only in optimum conditions of safety for people, animals and property.



IMPORTANT

- The manufacturer declines any liability for operations carried out on the appliance without respecting the instructions given in this manual.
- The manufacturer reserves the right to modify the appliances presented in this publication without notice.
- No part of this manual may be reproduced.
- This manual is available in digital format by:
 - contacting the dealer or reference customer care;
 - downloading the latest and up to date manual on the web site;
- The manual must always be kept in an easily accessed place near the appliance. Appliance operators and maintenance personnel must be able to easily find and consult it at any time.

Contents

A	WARNING AND SAFETY INFORMATION	5
A.1	General information	5
A.2	Personal protection equipment	6
A.3	General safety	6
A.4	Induction general safety	7
A.5	Protection devices installed on the appliance	8
A.6	Safety signs to be placed on the appliance or near its area	8
A.7	Reasonably foreseeable improper use	9
A.8	Residual risks	9
A.9	Transport, handling and storage	10
A.10	Installation and assembly	10
A.11	Electrical connection	11
A.12	Positioning	11
A.13	Appliance space limits	11
A.14	Appliance cleaning	11
A.15	Preventive Maintenance	11
A.16	Parts and accessories	12
A.17	Precautions for use and maintenance	12
A.18	Appliance maintenance	12
A.19	Appliance disposal	12
B	WARRANTY	12
B.1	Warranty terms and exclusions	12
C	TECHNICAL DATA	14
C.1	Dataplate position	14
C.2	Appliance and manufacturer's identification data	14
C.3	How to interpret the family Type	15
C.4	Induction appliances	15
D	GENERAL INFORMATION	16
D.1	Introduction	16
D.2	Intended use and restrictions	16
D.3	Testing and inspection	16
D.4	Copyright	16
D.5	Keeping the manual	16
D.6	Recipients of the manual	16
D.7	Definitions	16
D.8	Responsibility	16
D.9	Disposal of packing	17
E	INSTALLATION AND ASSEMBLY	17
E.1	Introduction	17
E.2	Customer's responsibilities	17
E.3	Connections introduction	17
E.4	Electrical connection	17
E.4.1	Electrical appliances	17
E.4.2	Circuit breaker	18
E.4.3	Equipotential node and Earth connection	18
E.5	Drop in installation	18
F	NORMAL USE	18
F.1	Characteristics of personnel trained for normal appliance use	18
F.2	Characteristics of personnel enabled to operate on the appliance	18
F.3	Operator qualified for normal appliance use	18
G	INSTRUCTION FOR THE USER	18
G.1	Introduction	18
G.1.1	Lamp Test	19
G.1.2	Induction griddle	19
G.1.3	Induction Wok	19
G.1.4	Induction hob	19
G.2	Induction griddle use	20
G.2.1	Switching on	20
G.2.2	Temperature level fine tuning	20
G.2.3	Lock	20
G.2.4	Model with double zone	20
G.2.5	Hob to hood (only with coupled Libero Point appliances)	21
G.2.6	Switch off	21
G.3	Induction wok and hob use	21
G.3.1	Switching on (all models)	21
G.3.2	Power level	21
G.3.3	Timer	21
G.3.4	Lock	21
G.3.5	Model with double zone (only hob model)	21
G.3.6	Hob to hood (only with coupled Libero Point appliances)	21
G.3.7	Switch off	21
G.4	Choice of pots	21

G.5	Cooking advice	22
H	APPLIANCE CLEANING AND MAINTENANCE.....	22
H.1	Ordinary maintenance	22
	H.1.1 Care information	22
	H.1.2 Cleaning the appliance and accessories	22
	H.1.3 Care of the unit – Daily	22
	H.1.4 Care of the unit – Monthly	23
	H.1.5 Periods of non-use	23
	H.1.6 Internal parts (every 6 months).....	23
H.2	Repair and extraordinary maintenance	24
H.3	Maintenance intervals.....	24
I	TROUBLESHOOTING	25
I.1	Introduction	25
I.2	Warnings codes	25
I.3	Inefficiencies detected during cooking	26
J	MACHINE DISPOSAL.....	26
J.1	Waste storage.....	26
J.2	Procedure regarding appliance dismantling macro operations	26
K	ENCLOSED DOCUMENTS.....	26

A WARNING AND SAFETY INFORMATION

A.1 General information

To ensure safe use of the appliance and a proper understanding of the manual it is necessary to be familiar with the terms and typographical conventions used in the documentation. The following symbols are used in the manual to indicate and identify the various types of hazards:



WARNING

Danger for the health and safety of operators.



WARNING

Danger of electrocution - dangerous voltage.



CAUTION

Risk of damage to the appliance or the product.



WARNING

Danger of magnetic fields.



IMPORTANT

Important instructions or information on the product



Equipotentiality



Read the instructions before using the appliance







Clarifications and explanations

- Only specialised personnel are authorised to operate on the appliance.
- This appliance is to be intended for commercial and collective use, for example in kitchens of restaurants, canteens, hospitals and in commercial enterprises such as bakeries, butcheries, etc., not for continuous mass production of food. Any other use is deemed improper.
- This appliance must not be used by minors and adults with limited physical, sensory or mental abilities or without adequate experience and knowledge regarding its use.
- Do not let children play with the appliance.
- Keep all packaging and detergents away from children.
- Cleaning and user maintenance shall not be made by children without supervision.
- For your safety do not store or use gasoline or other flammable vapours and liquids in the vicinity of this or any other appliance.
- Do not store explosive substances, such as pressurized containers with flammable propellant, in this appliance.
- Refer to the data given on the appliance's data plate for relations with the Manufacturer (e.g. when ordering spare parts, etc.).
- When scrapping the appliance, the marking must be destroyed.
- Save these instructions carefully for further consultation by the various operators.

A.2 Personal protection equipment

Summary table of the Personal Protection Equipment (PPE) to be used during the various stages of the appliance's service life.

Stage	Protective garments 	Safety footwear 	Gloves 	Glasses 	Safety helmet 
Transport	—	●	○	—	○
Handling	—	●	○	—	—
Unpacking	—	●	○	—	—
Installation	—	●	● ¹	—	—
Normal use	●	●	● ²	—	—
Adjustments	○	●	—	—	—
Routine cleaning	○	●	● ¹⁻³	○	—
Extraordinary cleaning	○	●	● ¹⁻³	○	—
Maintenance	○	●	○	—	—
Dismantling	○	●	○	○	—
Scrapping	○	●	○	○	—
Key:					
●	PPE REQUIRED				
○	PPE AVAILABLE OR TO BE USED IF NECESSARY				
—	PPE NOT REQUIRED				

1. During these operations, gloves must be cut-resistant. Failure to use the personal protection equipment by operators, specialized personnel or users can involve exposure to damage to health (depending on the model).

2. During these operations, gloves must be heatproof to protect hands from contact with hot food or hot parts of the appliance and/or when removing hot items from it. Failure to use the personal protection equipment by operators, specialised personnel or users can involve exposure to chemical risk and cause possible damage to health (depending on the model).

3. During these operations, gloves must be suitable for contact with chemical substances used (refer to the safety data sheet of the substances used for information regarding the required PPE). Failure to use the personal protection equipment by operators, specialized personnel or users can involve exposure to chemical risk and cause possible damage to health (depending on the model).

A.3 General safety

- The appliances are provided with electric and/or mechanical safety devices for protecting workers and the appliance itself.
- Never operate the appliance, removing, modifying or tampering with the guards, protection or safety devices.
- Do not make any modifications to the parts supplied with the appliance.
- Several illustrations in the manual show the appliance, or parts of it, without guards or with guards removed. This is purely for explanatory purposes. Do not use the appliance without the guards or with the protection devices deactivated.

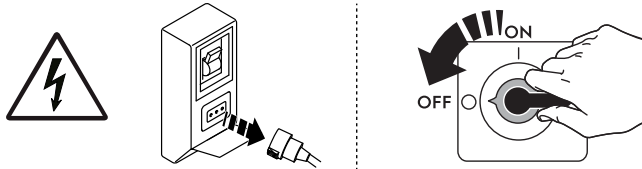

Disconnect the appliance from the power supply before carrying out any installation, assembly, cleaning or maintenance procedure.

- Do not remove, tamper with or make illegible the marking and safety, danger and instruction signs and labels on the appliance.
- The A-weighted emission sound pressure level does not exceed 70 dB(A).
- Turn the appliance off in case of fault or poor operation.
- Do not use products (even if diluted) containing chlorine (sodium hypochlorite, hydrochloric or muriatic acid, etc.) to clean the appliance or the floor under it.
- Do not spray aerosols in the vicinity of this appliance while it is in operation.
- Install the appliance under conditions of adequate ventilation in order to provide a suitable air change per hour. Make sure that the ventilation system, whatever it is, always remains operational and efficient for the entire period of time during which the equipment is operating.
- Do not obstruct the flow of combustion and ventilation air.
- The following operations have to be carried out by specialised authorised personnel or Customer Care Service provided with all the appropriate personal protection equipment (*A.2 Personal protection equipment*), tools, utensils and ancillary means, who can ask the manufacturer to supply a servicing manual:
 - Installation and assembly
 - Positioning
 - Electrical connection
 - Appliance cleaning, repair and extraordinary maintenance
 - Appliance disposal
 - Work on electrical equipment

A.4 Induction general safety

- The hotplate cannot be cooled with direct jets of water, intentional or accidental (e.g. when filling pots with water from a side pourer or spill onto the hot-plate).
- The glass-ceramic top (4mm thickness, only Libero range) could be damaged due to punctiform impacts (e.g. falling of metal object on the surface) or hard handling of the pots.
- If the surface is damaged or cracked, immediately disconnect the appliance or appropriate part of the appliance from the supply.
- During every normal cooking process the glass-ceramic top is very hot and therefore must not be touched (burns danger).
- During every normal cooking process must not be left empty pans onto the glass-ceramic top (overheating danger).
- During every normal cooking process do not place paper, cardboard, cloths, etc., between the pot and the glass-ceramic top (risk of fire).
- During every normal cooking process no other object (e.g. plastic vessels, closed tinned foods, aluminium foil, cutlery or other metal objects) except pots, must be placed on the hotplate (burns danger). The hotplate must not be used as a rest surface.
- If a splashguard device is used for cooking, it must not have a metal surface.
- During every normal cooking process, objects such as rings, watches, etc., worn by the user can become very hot if brought near the surface of the appliance (burns danger).

- **Anyone fitted with a pacemaker or other metal implants can suffer life-threatening injuries when using induction appliances.** Ask the manufacturer of your implant or consult your doctor about possible risks before using the cooker.
- Every kind of objects that react to magnetisation (e.g. credit cards, telephone cards, etc.) must not be placed near or above the glass-ceramic top.
- The induction appliance has internal air cooling. The air intake and outlet openings located under the appliance must not be blocked with objects or cloths (overheating danger).
- At the end of cooking always switch off the cooking zones.
- It is advisable to use pots specially designed for this induction appliance (refer to G.4 *Choice of pots*), otherwise the appliance may malfunction or become damaged.



A.5 Protection devices installed on the appliance



Guards



The appliance has:

- fixed guards (e.g. casings, covers, side panels, etc.), fixed to the appliance and/or frame with screws or quick-release connectors that can only be removed or opened with tools; therefore the user must not remove or tamper with such devices. The Manufacturer declines any liability for damage due to tampering or their non-use;
- interlocked movable guards (door) for access inside the appliance;
- appliance electrical equipment access doors, made from hinged panels openable with tools. The door must not be opened when the appliance is connected to the power supply.

A.6 Safety signs to be placed on the appliance or near its area

Prohibition	Meaning
	do not remove the safety devices
	do not use water to extinguish fires (placed on electrical parts)
	Keep the area around the appliance clear and free from combustible materials. Do not keep flammable materials in the vicinity of the appliance

Danger	Meaning
	caution hot surface
	danger of electrocution (shown on electrical parts with indication of voltage)

Danger	Meaning
	risk of electromagnetic fields
	Access forbidden to wearers of electrical stimulator (pacemakers)

A.7 Reasonably foreseeable improper use

Improper use is any use different from that specified in this manual. During appliance operation, other types of work or activities deemed improper and that in general can involve risks for the safety of operators and damage to the appliance are not allowed. Reasonably foreseeable improper use includes:

- lack of appliance maintenance, cleaning and periodical checks;
- structural changes or modifications to the operating logic;
- tampering with the guards or safety devices;
- failure to use personal protection equipment by operators, specialised personnel and maintenance personnel;
- failure to use suitable accessories (e.g. use of unsuitable equipment or ladders);
- keeping combustible or flammable materials, or in any case materials not compatible with or pertinent to the work, near the appliance;
- wrong appliance installation;
- placing in the appliance any objects or things not compatible with its use, or that can damage the appliance, cause injury or pollute the environment;
- climbing on the appliance;
- non-compliance with the requirements for correct appliance use;
- other actions that give rise to risks not eliminable by the Manufacturer.



WARNING

The previously described actions are prohibited!

A.8 Residual risks

The appliance has several risks that were not completely eliminated from a design standpoint or with the installation of adequate protection devices. Nevertheless, through this manual the Manufacturer has taken steps to inform operators of such risks, carefully indicating the personal protection equipment to be used by them. In order to reduce the risks, provide for sufficient spaces while installing the unit.

To preserve these conditions, the areas around the appliance must always be:

- kept free of obstacles (e.g. ladders, tools, containers, boxes, etc.);
- clean and dry;
- well lit.

For the Customer's complete information, the residual risks remaining on the appliance are indicated below: such actions are deemed improper and therefore strictly forbidden.

Residual risk	Description of hazardous situation
Slipping or falling	The operator can slip due to water, any liquid or dirt on the floor
Burns/abrasions (e.g. heating elements, cold pan, cooling circuit plates and pipes)	The operator deliberately or unintentionally touches some components inside the appliance without using protective gloves.
Electrocution	Contact with live parts during maintenance operations carried out with the electrical panel powered
Crushing or injury	The specialised personnel may not correctly fix the control panel when accessing the technical compartment. The panel could close suddenly.
Tipping of loads	When handling the appliance or the packing containing it, using unsuitable lifting systems or accessories or with the unbalanced load
Chemical	Contact with chemical substances (e.g. detergent, rinse aid, scale remover, etc.) without taking adequate safety precautions. Therefore always refer to the safety cards and labels on the products used.
Sudden closing of the lid/door/ oven door (if present, depending on the appliance type)	The operator for normal appliance use could suddenly and deliberately close (if present, depending on the appliance type): <ul style="list-style-type: none"> • lid • door/s • drawers

A.9 Transport, handling and storage

- Please refer to indications on packaging for stackability during transport, handling and storage.
- Do not stand under suspended loads during loading or unloading operations. Unauthorized personnel must not enter the work area.
- The weight of the appliance alone is not sufficient to keep it steady.
- For appliance lifting and anchoring, do not use movable or weak parts such as: casings, electrical raceways, pneumatic parts, etc.
- Do not push or pull the appliance to move it, as it may tip over. Use proper tool to lift the appliance.
- Arrange a suitable area with flat floor for appliance unloading and storage operations.
- Appliance transport, handling and storage personnel must be adequately instructed and trained regarding the safely use of lifting systems and personal protection equipment suitable for the type of operation carried out.
- When removing the anchoring systems, make sure the stability of the appliance parts does not depend on the anchoring and, therefore, that this operation does not cause the load to fall off the vehicle. Before unloading the appliance components, make sure all the anchoring systems are removed.

A.10 Installation and assembly

- The operations described must be carried out in compliance with the current safety regulations and provisions in force in the country of use.

- The plug, if present, must be accessible after positioning the appliance in the place of installation.
- The appliance is not suitable for installation outdoors and/or in places exposed to atmospheric agents (rain, direct sunlight, etc.).

A.11 Electrical connection

- The power supply system must be suitable for the rated current of the connected appliance; the connection must be carried out in compliance with the regulations and provisions in force in the country of use.
- The information regarding the appliance power supply voltage is given on the dataplate.
- Install between the power cable and the electric line a differential thermal-magnetic switch suitable for the absorption specified on the data plate, with contact gap enabling complete disconnection in category III overvoltage conditions and complying with the regulations in force.
- If the power cable is damaged, it must be replaced by the Customer Care Service or in any case by specialised personnel, in order prevent any risk.
- The manufacturer declines any liability for damage or injury resulting from breach of the above rules or non-compliance with the electrical safety regulations in force in the country where the appliance is used.
- Verify that a safety circuit breaker is installed between the power cable of the appliance and the mains electric line. The contact opening max. distance and leakage current must comply with the local safety regulations.

A.12 Positioning

- Install the appliances, taking all the safety precautions required for this type of operation, also respecting the relevant fire-prevention measures.
- Prevent the areas where the appliance is installed to be polluted with corrosive substances (chlorine, etc.). In case such prevention cannot be guaranteed, the entire stainless steel surface has to be coated by a paraffin protective film spread by using a rag soaked with paraffin. The manufacturer declines any liability for corrosive effects due to external causes.

A.13 Appliance space limits

- The appliances are not suitable for recess-mounting. Leave a space of at least 10 between the appliance and side walls and 10 from the rear wall, or in any case an adequate space to enable subsequent servicing or maintenance operations.
- Maintain a distance of at least 50 mm between the appliance and any combustible walls. Do not store or use flammable materials and liquids near the appliance.

A.14 Appliance cleaning

- Do not touch the appliance with wet hands or feet or when barefoot.
- Put the appliance in safe conditions before starting any cleaning operation.
- Do not allow oil or grease to come into contact with plastic parts. Do not allow dirt, fat, food or other residuals to form deposits on the appliance.
- Respect the requirements for the various routine and extraordinary maintenance operations. Non-compliance with the instructions can create risks for personnel.
- Do not spray water or use water jets, steam cleaner or high pressure cleaner.

A.15 Preventive Maintenance

In order to ensure the safety and performance of your equipment, it is recommended that service is undertaken by Electrolux Professional authorised engineers every 12 months, in

accordance with Electrolux Professional Service Manuals. Please contact your local Electrolux Professional Service Centre for further details.

A.16 Parts and accessories

Use only original accessories and/or spare parts. Failure to use original accessories and/or spare parts will invalidate the original manufacturer warranty and may render the appliance not compliant with the safety standard.

A.17 Precautions for use and maintenance

- Risks mainly of a mechanical, thermal and electrical nature exist in the appliance. Where possible the risks have been neutralised:
 - directly, by means of adequate design solutions.
 - indirectly by using guards, protection and safety devices.
- Any anomalous situations are signalled on the control panel display.
- During maintenance several risks remain, as these could not be eliminated, and must be neutralised by adopting specific measures and precautions.
- Do not carry out any checking, cleaning, repair or maintenance operations on moving parts. Workers must be informed of this prohibition by means of clearly visible signs.
- To guarantee appliance efficiency and correct operation, periodical maintenance must be carried out according to the instructions given in this manual.
- Make sure to periodically check correct operation of all the safety devices and the insulation of electrical cables, which must be replaced if damaged.

A.18 Appliance maintenance

- The inspection and maintenance intervals depend on the actual appliance operating conditions and ambient conditions (presence of dust, damp, etc.), therefore precise time intervals cannot be given. In any case, careful and periodical appliance maintenance is advisable in order to minimise service interruptions.
- It is advisable to stipulate a preventive and scheduled maintenance contract with the Customer Care Service.
- Put the appliance in safe conditions before starting any maintenance operation.
- To guarantee appliance efficiency and correct operation, periodical maintenance must be carried out according to the instructions given in the manual.

A.19 Appliance disposal

- Make the appliance unusable by removing the power cable and any compartment closing devices, to prevent the possibility of someone becoming trapped inside.

B WARRANTY

B.1 Warranty terms and exclusions

If the purchase of this product includes warranty coverage, warranty is provided in line with local regulations and subject to the product being installed and used for the purposes as designed, and as described within the appropriate equipment documentation.

Warranty will be applicable where the customer has used only genuine spare parts and has performed maintenance in accordance with Electrolux Professional user and maintenance documentation made available in paper or electronic format.

Electrolux Professional strongly recommends using Electrolux Professional approved cleaning, rinse and descaling agents to obtain optimal results and maintain product efficiency over time.

The Electrolux Professional warranty does not cover:

- service trips cost to deliver and pick up the product;
- installation;
- training on how to use/operate;
- replacement (and/or supply) of wear and tear parts unless resulting from defects in materials or workmanship reported within one (1) week from the failure;
- correction of external wiring;
- correction of unauthorized repairs as well as any damages, failures and inefficiencies caused by and/or resulting from:
 - insufficient and/or abnormal capacity of the electrical systems (current/voltage/frequency, including spikes and/or outages);
 - inadequate or interrupted water supply, steam, air, gas (including impurities and/or other that does not comply with the technical requirements for each appliance);

- plumbing parts, components or consumable cleaning products that are not approved by the manufacturer;
- customer's negligence, misuse, abuse and/or non-compliance with the use and care instructions detailed within the appropriate equipment documentation;
- improper or poor: installation, repair, maintenance (including tampering, modifications and repairs carried out by third parties not authorized) and modification of safety systems;
- Use of non-original components (e. g.: consumables, wear and tear, or spare parts);
- environment conditions provoking thermal (e. g. overheating/freezing) or chemical (e. g. corrosion/oxidation) stress;
- foreign objects placed in- or connected to- the product;
- accidents or force majeure;
- transportation and handling, including scratches, dents, chips, and/or other damage to the finish of the product, unless such damage results from defects in materials or workmanship and is reported within one (1) week of delivery unless otherwise agreed;
- product with original serial numbers that have been removed, altered or cannot be readily determined;
- replacement of light bulbs, filters or any consumable parts;
- any accessories and software not approved or specified by Electrolux Professional.

Warranty does not include scheduled maintenance activities (including the parts required for it) or the supply of cleaning agents unless specifically covered within any local agreement, subject to local terms and conditions.

Check on Electrolux Professional website the list of authorized customer care.

C TECHNICAL DATA

C.1 Dataplate position



IMPORTANT

This instruction manual contains information relevant to various appliances. See the dataplate located under the control panel to identify the appliance (see fig. below).

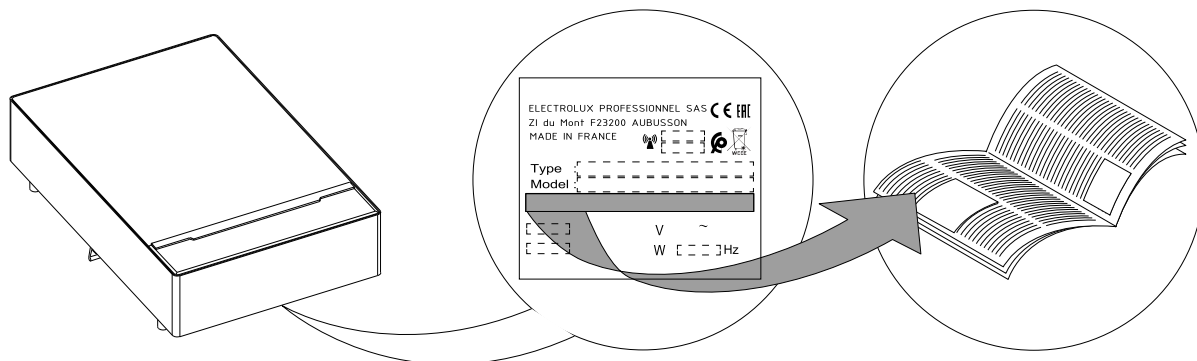

IMPORTANT

When installing the appliance, make sure the electrical connection is carried out in compliance with that specified on the data plate.

C.2 Appliance and manufacturer's identification data

An example of the marking or dataplate on the machine is given below:

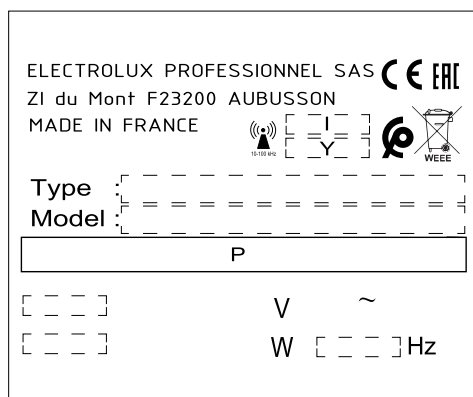

The dataplate gives the product identification and technical data. The meaning of the various information given on it is listed below:

Type	Family type
Model	Factory description of product
P	Product Number Code and Serial Number
V	Power supply voltage
W	Max. power input
Hz	Power supply frequency
CE	CE marking
I	dust and water protection rating
Y	year of production
Electrolux Professionel SAS ZI du Mont F23200 Aubusson France	manufacturer

C.3 How to interpret the family Type

The factory description on the data plate has the following meaning:

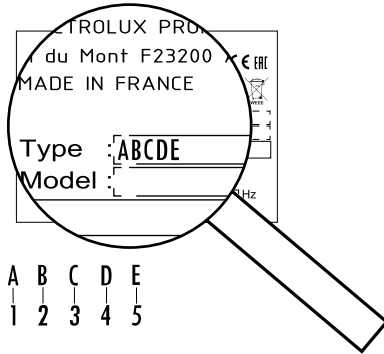

1 - Product / Brand

LL Libero Line

2 - Function Type

F	Flat
W	Wok
FT	Fry Top

3 - Size / zones

S	Single zone
D	Double zone

4 - Power Supply / Phases

1	1 Phase
3	3 Phases

5 - Module Type

S	Stand Alone
D	Drop In

C.4 Induction appliances

Induction Griddle				
Type		LLFTS1S		LLFTD3S
Appliance description		Single Zone	Single Zone (UK)	Double Zone
Models		E1IREEOMCS Z1IREEOMCS	E1IREEOMCU	E1IREDOMES Z1IREDOMES
Power supply voltage	V	220 — 240		380 — 415
Frequency	Hz.	50 – 60		50 — 60
Phases	Nr.	1N~		3N~
Max current	A	16	13	16
Max total power	kW	3.5	3	7
Plug	Type	F (Schuko)	G	3N+PE 16A (IEC 60309)

Induction Hob						
Type		LLFS1S LLFS1D		LLFS3S LLFS3D	LLFD1S LLFD1D	
Appliance description		Single Zone	Single Zone (UK)	Single Zone	Double Zone	Double Zone (UK)
Models		E1HDEDOMCS E1HDEEOMCS Z1HDEDOMCS Z1HDEEOMCS	E1HDEDOMCU E1HDEEOMCU	E1HDDOMCT E1HDDEOMCT Z1HDDDOMCT Z1HDDEOMCT	E1HAEDOMCS E1HAEEOMCS Z1HAEDOMCS Z1HAEEOMCS	E1HAEDOMCU E1HAEEOMCU
Power supply voltage	V	220 – 240		380 – 415	220 – 240	
Frequency	Hz.	50 – 60		50 – 60	50 – 60	
Phases	Nr.	1N~		3~	1N~	
Max current	A	16	13	7	16	13
Max total power	kW	3.5	3	5	3.5	3
Plug	Type	F (Schuko)	G	3N+PE 16A (IEC 60309)	F (Schuko)	G

Induction Wok				
Type		LLWS1S LLWS1D		LLWS3S LLWS3D
Appliance description		Single Zone	Single Zone (UK)	Single Zone
Models		E1HCEDOMCS E1HCEEOMCS Z1HCEDOMCS Z1HCEEOMCS	E1HCEDOMCU E1HCEEOMCU	E1HCDDOMCT E1HCDEOMCT Z1HCDDOMCT Z1HCDEOMCT
Power supply voltage	V	220 – 240		380 — 415
Frequency	Hz.	50 – 60		50 – 60
Phases	Nr.	1N~		3~

Induction Wok				
Type		LLWS1S LLWS1D		LLWS3S LLWS3D
Appliance description		Single Zone	Single Zone (UK)	Single Zone
Models		E1HCEDOMCS E1HCEEOMCS Z1HCEDOMCS Z1HCEEOMCS	E1HCEDOMCU E1HCEEOMCU	E1HCDDOMCT E1HCDEOMCT Z1HCDDOMCT Z1HCDEOMCT
Max current	A	16	13	7
Max total power	kW	3.5	3	5
Plug	Type	F (Schuko)	G	3N+PE 16A (IEC 60309)

D GENERAL INFORMATION



WARNING

Refer to “*WARNING and Safety Information*”

D.1 Introduction

The drawings and diagrams given in the manual are not in scale. They supplement the written information with an outline, but are not intended to be a detailed representation of the appliance supplied.

The numerical values given on the appliance installation diagrams refer to measurements in millimeters and/or inches.

D.2 Intended use and restrictions

This appliance is designed for cooking food. It is intended for collective use.

Any other use is deemed improper.



NOTE!

The manufacturer declines any liability for improper use of the product.

D.3 Testing and inspection

Our appliances have been designed and optimized, with laboratory testing, in order to obtain high performance and efficiency.

Passing of the tests (visual inspection - gas/electrical test - functional test) is guaranteed and certified by the specific enclosures.

D.4 Copyright

This manual is intended solely for consultation by the operator and can only be given to third parties with the permission of Electrolux Professional company.

D.5 Keeping the manual

The manual must be carefully kept for the entire life of the appliance, until scrapping. The manual must stay with the appliance in case of transfer, sale, hire, granting of use or leasing.

D.6 Recipients of the manual

This manual is intended for:

- the carrier and handling personnel;
- installation and commissioning personnel;
- the employer of appliance users and the workplace manager;
- operators for normal appliance use;
- specialised personnel - Customer Care service (see service manual).

D.7 Definitions

Listed below are the definitions of the main terms used in the manual. It is advisable to read them carefully before use.

Operator	appliance installation, adjustment, use, maintenance, cleaning, repair and transport personnel.
Manufacturer	Electrolux Professional SpA or any other service centre authorised by Electrolux Professional SpA.
Operator for normal appliance use	an operator who has been informed and trained regarding the tasks and hazards involved in normal appliance use.
Customer Care service or specialised personnel	an operator instructed/trained by the Manufacturer and who, based on his professional and specific training, experience and knowledge of the accident-prevention regulations, is able to appraise the operations to be carried out on the appliance and recognise and prevent any risks. His professionalism covers the mechanical, electrotechnical and electronics fields etc.
Danger	source of possible injury or harm to health.
Hazardous situation	any situation where an operator is exposed to one or more hazards.
Risk	a combination of probabilities and risks of injury or harm to health in a hazardous situation.
Protection devices	safety measures consisting of the use of specific technical means (guards and safety devices) for protecting operators against risks.
Guard	an element of a appliance used in a specific way to provide protection by means of a physical barrier.
Safety device	a device (other than a guard) that eliminates or reduces the risk; it can be used alone or in combination with a guard.
Customer	the person who purchased the appliance and/or who manages and uses it (e. g. company, entrepreneur, firm).
Electrocution	an accidental discharge of electric current on a human body.

D.8 Responsibility

The Manufacturer declines any liability for damage and malfunctioning caused by:

- non-compliance with the instructions contained in this manual;
- repairs not carried out in a workmanlike fashion, and replacements with parts different from those specified in the spare parts catalogue (the fitting and use of non-original spare parts and accessories can negatively affect appliance operation and invalidates the original manufacturer warranty);
- operations carried out by non-specialised personnel;

- unauthorized modifications or operations;
- missing, lack or inadequate maintenance;
- improper appliance use;
- unforeseeable extraordinary events;
- use of the appliance by uninformed and / or untrained personnel;
- non-application of the current provisions in the country of use, concerning safety, hygiene and health in the workplace.

The Manufacturer declines any liability for damage caused by arbitrary modifications and conversions carried out by the user or the Customer.

The employer, workplace manager or service technician are responsible for identifying and choosing adequate and suitable personal protection equipment to be worn by operators, in compliance with regulations in force in the country of use.



The Manufacturer declines any liability for inaccuracies contained in the manual, if due to printing or translation errors.

Any supplements to the installation, use and maintenance manual the Customer receives from the Manufacturer will form an integral part of the manual and therefore must be kept together with it.

D.9 Disposal of packing

The packing must be disposed of in compliance with the current regulations in the country where the appliance is used. All the packing materials are environmentally friendly.

They can be safely kept, recycled, or burned in an appropriate waste incineration plant. Recyclable plastic parts are marked as follows:

 PE	Polyethylene <ul style="list-style-type: none"> • Outer wrapping • Instructions bag
 PP	Polypropylene <ul style="list-style-type: none"> • Straps
 PS	Polystyrene foam <ul style="list-style-type: none"> • Corner protectors

The parts in wood and cardboard can be disposed of, respecting the current regulations in the country where the appliance is used.

E INSTALLATION AND ASSEMBLY

E.1 Introduction



WARNING

Refer to “*WARNING and Safety Information*”.

To ensure correct operation of the appliance and maintain safe conditions during use, carefully follow the instructions given below in this section.



CAUTION

Before moving the appliance make sure the load bearing capacity of the lifting equipment used is suitable for its weight.



WARNING

The appliance is marked with the induction generator frequency or frequency range in kHz.



WARNING

The appliance generates magnetic fields; frequency range: 10-100 kHz.

E.2 Customer's responsibilities

The tasks and works required of the Customer are:

- arrange an earthed power socket of suitable capacity for the input specified on the data plate;
- prearrange a high-sensitivity manual-reset magneto-thermal circuit-breaker;
- prearrange a device lockable in the open position for the connection to the power supply.
- for information regarding the electrical connection, refer to “A.11 *Electrical connection*”;
- check the floor planarity on which the appliance is placed.

E.3 Connections introduction

- Any installation work or maintenance to the supply system must only be carried out by the utility company or an authorised installation technician.
- Refer to the appliance dataplate for the product code.
- See the installation diagram for the type and position of appliance connections.

E.4 Electrical connection

E.4.1 Electrical appliances



WARNING

Work on the electrical systems must only be carried out by specialised personnel.



IMPORTANT

Connection to the power supply must be carried out in compliance with the regulations and provisions in force in the country of use.

Before connecting, make sure that:

1. The system power supply is arranged and able to take the actual current load and that it is executed in a workmanlike manner according to the regulations in force in the country of use.
2. The plug must be accessible after positioning the appliance in the place of installation. Make sure the plug is not crushed by the appliance. A damaged power cable can overheat and catch fire or cause a short circuit.
3. Make sure the machine power supply voltage specified on the data plate matches the mains voltage.
4. Make sure that the socket has an efficient ground contact.
5. Connect the mains plug to the mains socket only at the end of the installation.
6. Always use a correctly installed shockproof socket.
7. Do not use multi-plug adapters and extension cables.
8. Do not pull the mains cable to disconnect the appliance. Always pull the mains plug.
9. Do not touch the mains cable or the mains plug with wet hands.
10. The equipment must also be included in an equipotential system, whose connection is made by means of screw

“EQ” (see “Installation diagram”) indicated by the symbol .

E.4.2 Circuit breaker

Verify that a safety circuit breaker is installed between the power cable of the appliance and the mains electric line. The contact opening max. distance and leakage current must comply with the local safety regulations.

E.4.3 Equipotential node and Earth connection

Connect the appliance to an earth; it must be included in an equipotential node by means of the screw located under the frame.

The screw is marked with the symbol .

E.5 Drop in installation

For a correct installation use the dimensions specified in the image below.

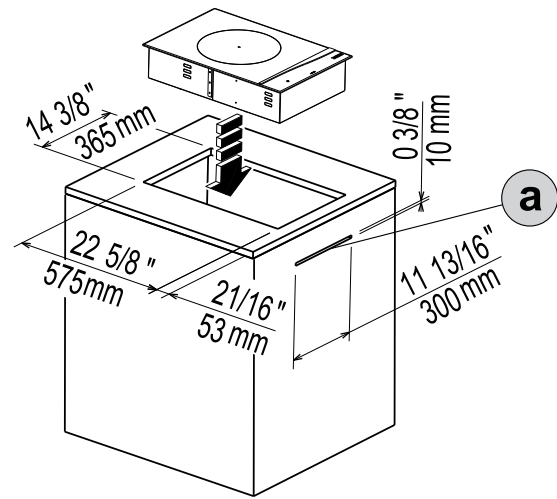

“a” Air suction hole minimum section: 3000 mm²



NOTE!

There are available as accessory a “fixing kit” able to block the appliance on top without using glue or silicon, and an “air suction kit” able to guarantee the right suction of fresh air.

F NORMAL USE



WARNING

Refer to “*WARNING and Safety Information*”

F.1 Characteristics of personnel trained for normal appliance use

The Customer must make sure the personnel for normal appliance use are adequately trained and skilled in their duties, as well as ensuring their own safety and that of other persons.

The Customer must make sure his personnel have understood the instructions received and in particular those regarding work hygiene and safety in use of the appliance.

F.2 Characteristics of personnel enabled to operate on the appliance

The Customer is responsible for ensuring that persons assigned to the various duties:

- read and understand the manual;
- receive adequate training and instruction for their duties in order to perform them safely;

- receive specific training for correct appliance use.

F.3 Operator qualified for normal appliance use

Must have at least:

- knowledge of the technology and specific experience in operating the appliance;
- adequate general basic education and technical knowledge for reading and understanding the contents of the manual, including correct interpretation of the drawings, signs and pictograms;
- sufficient technical knowledge for safely performing his duties as specified in the manual;
- knowledge of the regulations on work hygiene and safety.

In case of a significant anomaly (e. g. short circuits, wires coming out of the terminal block, motor breakdowns, worn electrical cable sheathing, etc.) the operator for normal appliance use must:

- immediately deactivate the appliance and disconnect all the supplies (electricity, gas, water).

G INSTRUCTION FOR THE USER



WARNING

Refer to “*WARNING and Safety Information*”.

G.1 Introduction

Induction appliances are made to stand on a table.

The installation diagrams show the appliance dimensions.

These appliances must not be positioned into any machine, furniture, cabinet or whatever else unit.

Leave sufficient space between the appliance and any surface that may be flammable.

These devices can be moved manually and can be connected to an electric socket using their plug.

In order to reduce energy consumption, avoid using the appliance empty for long periods or in conditions that compromise optimal efficiency.

These appliances (except griddles) does not require preheating. Therefore they does not have to be left on continuously but switched on only at the time of use.

The most important advantages of an induction cooking system are the following:

1. high power efficiency;
2. quick to use, because full heating power is promptly available within the bottom of the used pot or pan;
3. the power control is precise with no inertia over a very wide range;
4. the User Interface in all the models of the range has similar look and functionalities;
5. excellent energy savings, high conversion rate;
6. inexpensive to run;

7. excellent uniformity;
8. easy cleaning of the glass ceramic hotplate / griddle-plated .



IMPORTANT

Do not cover the display with any kind of hot pot, vessel or container.

G.1.1 Lamp Test

Each switch on, the appliance performs a Lamp test; the display will light up in a predetermined order, showing the following information:

1. Software version;
2. Appliance configuration.

G.1.2 Induction griddle

Induction griddle is a versatile tabletop appliance to cook and roast meat, sausages, hamburgers, poultry fish (in tin foil), food in breadcrumbs, eggs, vegetables, etc;

The smooth griddle is available in single (half module) or double (full module) zone: both zones can either be operated separately or together;

The set can be continuously adjusted from room temperature up to 280°C and is thermostatically controlled;

Keeping clean is easy thanks to the front drip tray, which collects any fluid (oil, grease...) and debris generated while cooking, as well as scraped off residues or liquids for cleaning after use;

Splash guards on three sides reduce soiling around the appliance.

Induction griddle display functions

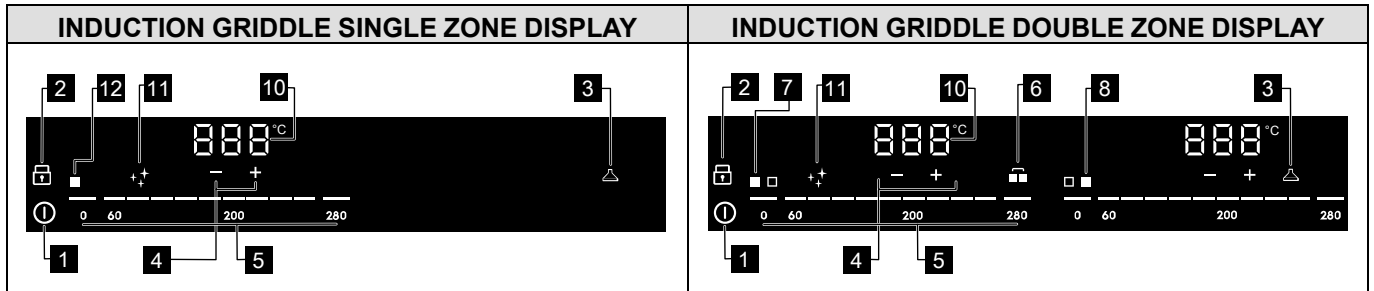

TOUCH SENSOR	FUNCTION	EXPLANATORY NOTES
1 —	ON/OFF	Griddle is activated/deactivated
2 —	Lock function	Lock function prevent to change settings accidentally
3 —	IR communication between appliances and air filtration system of the mobile counter	Automatic regulation of the mobile counter fan speed according to cooking intensity
4 —	Minus and plus	Increases / decreases temperature fine tuning set
5 —	Temperature level slider	Set the temperature
6 —	Bridge function – merge of cooking zone (only for double zone griddle)	Drive together the cooking zone
7 —	Left zone (only for griddle double zone)	Indicates that the left zone of the appliance is switched on
8 —	Right zone	Indicates that the right zone of the appliance is switched on
10 —	Display temperature set	Indicates the value of the temperature set
11 —	Clean function	Fast function for setting right temp for cleaning.
12 —	Single zone	Indicates that the appliance is switched on

G.1.3 Induction Wok

The wok ceramic—glass surface is shaped to work with wok pans in order to preparation of “retail” dishes, and in particular chinese specialities.

Induction heating system is heavily fast and could induce very high temperature is short time with risk of oil smoke or fire.

G.1.4 Induction hob

The cooking surface is made from ceramic-glass.

Induction cooking hobs are used for boiling, braising, frying, regenerating and in general preparing numerous dishes in a special cookware (suitable on purpose for induction): cookware dimension could affect the correct work and diameters of the bottom surfaces below a certain value will not work.

Any other use is considered to be inappropriate.

The ceramic—glass hotplate serves as a cooking area for hob bottomed saucepans and sauté pans.

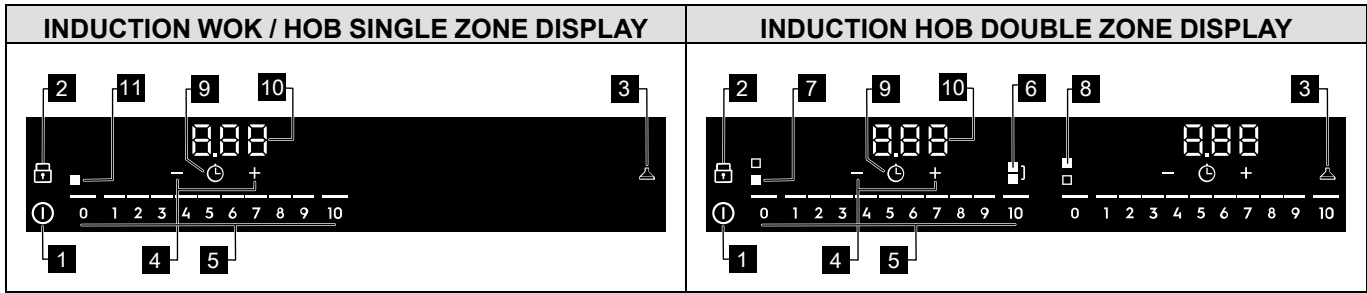

BUTTON SENSOR	FUNCTION	EXPLANATORY NOTES
1 —	ON/OFF	Hob / wok is activated/deactivated
2 —	Lock function	Lock function prevent to change settings accidentally
3 —	IR communication between appliances and air filtration system of the mobile counter	Automatic regulation of the mobile counter fan speed according to cooking intensity
4 —	Minus and plus	Increases / decreases time
5 —	Power level slider	Set the power level
6 —	Bridge function – merge of cooking zone (only for double zone induction)	Drive together the cooking zone
7 —	Front side (only for double zone)	Indicates the presence of a pot on the front zone of the hob
8 —	Rear side (only for double zone)	Indicates the presence of a pot on the rear zone of the hob
9 —	Countdown	Activates the countdown
10 —	display timer	It is the countdown displaying the remaining time in minutes or seconds to the power switch off
10 —	Single zone and wok	Indicates the presence of a pot on the hob / wok

G.2 Induction griddle use

Each heating zone is controlled by a touch board.

G.2.1 Switching on

Touch the button : the griddle will be prompted to use, waiting for one or both cooking zones to be energized.

Set the temperature between 60 and 280°C by sliding the control panel or touching it in different positions to activate pre-setted temperature: the relevant indication icon will be lit while the display will show the set temperature.

The touch temperature control panel has the following positions:

- “0“: zone off;
- “60“: minimum temperature;
- “280“: maximum temperature.



IMPORTANT

The appliance is always switched on, also when nothing is cooking.

G.2.2 Temperature level fine tuning

Fine temperature regulation allow to adjust the set with a precision of 1 degree.

Press the button : the cooking zones will be merged and will be operable through the left side hand touch panel only:

- Touch the control panel to set the desired temperature level or slide your finger along the control bar until reaching the desired displayed set
- Touch the button to increase or decrease the temperature, with steps of 1 degree.

G.2.3 Lock

It is possible to lock the control panel while the cooking zones are in operation, in order to prevent accidental changes of the power level.

To activate the function, press the button for three seconds; the corresponding indicator turn red and blinks.

To deactivate the function, touch the button again; the previously set power level lights up.



NOTE!

Should any object inadvertently touch the control panel, after 5 seconds there will be emitted 4 acoustic signals and the unit will turn off.

G.2.4 Model with double zone

The double zone model has two cooking zones, either operable separately through two touch panels or possible to operate in merged mode through one touch panel.

Independent zones mode

- It is possible setting two different temperatures; the appliance will automatically deliver the required amount of energy to each cooking zone.



IMPORTANT

Although two cooking zones operable separately, if setting two different temperatures the zone with the lower temperature set will automatically heated at higher temperature because the cooking plate will transfer the heat from the higher temperature set zone.

Merged zones mode

- Pressing the button : the cooking zones will be merged and will be operable through the left side hand touch panel only.

G.2.5 Hob to hood (only with coupled Libero Point appliances)

This is an advanced automatic function that connects the hob to the Libero Point's hood.

Both the hob and the hood have an infrared signal communicator.

The fan speed is automatically set based on the mode settings and the temperature of the hottest pan on the hob; this automatic mode is identified by a fixed red icon .

It is also possible to switch to manual mode pressing the  button; in this case the fan reaches the maximum speed and the red icon starts blinking; pressing the button again the system goes back to the previous automatic mode.

G.2.6 Switch off

Press the  button to switch off the appliance.



WARNING



At the end of each working day do not disconnect the equipment or switch off the power until the cooking elements have cooled properly and all the indication will disappear from the display.

G.3 Induction wok and hob use

Each heating zone is controlled by a touch board.

G.3.1 Switching on (all models)

Touch the button  to switch on the appliance.

When a suitable pot is positioned on the surface of the hob, the icons  or  will be lit and appliance is ready for setting the power level.

Set the energy level between 1 and 10 touching the button .

The touch energy control panel has the following positions:

- “0”: zone off;
- “1”: minimum power;
- “10”: maximum power.

If there are unsuitable pot or no pots on the surface, the display start to blink at 2-second intervals, then cut off the energy and switch off in 2 minutes; placing a pot on the hob surface again, the energy supply resumes.



G.3.2 Power level

Press the button  to set or change the power level:

- Touch the control panel to set the desired power level or slide your finger along the control bar until reaching the required level.

G.3.3 Timer

This function allows you to set the duration of the cooking.

To activate the function, press the  button, then press  to set the desired cooking time, shown in minutes on the display ; under the minute, the countdown continues in seconds.

At the end of the countdown an acoustic signal is emitted, the cooking zone is deactivated and the power level drop to zero.

G.3.4 Lock

It is possible to lock the control panel while the cooking zones are in operation, in order to prevent accidental changes of the power level.

To activate the function, press the  button for three seconds; the corresponding indicator turn red and blinks.

To deactivate the function, touch the  button again; the previously set power level lights up.



NOTE!

Should any object inadvertently touch the control panel, after 5 seconds there will be emitted 4 acoustic signals and the unit will turn off.

G.3.5 Model with double zone (only hob model)

On the double zone model there are two touch control panels. The two zones can work in independent or merged mode.

Independent zones mode

- Setting different power levels each zone, the total amount (sum of front zone + rear zone) of the set power level, will not exceed maximum power.

Merged zones mode

- Pressing the  button it is possible to control both zones from the left control panel.
- Whatever power level is set on the control panel, from 1 to 5 it will be equally distributed on the two cooking zones.

G.3.6 Hob to hood (only with coupled Libero Point appliances)

This is an advanced automatic function that connects the hob to the Libero Point's hood.

Both the hob and the hood have an infrared signal communicator.

The fan speed is automatically set based on the mode settings and the temperature of the hottest pan on the hob; this automatic mode is identified by a fixed red icon .

It is also possible to switch to manual mode pressing the  button; in this case the fan reaches the maximum speed and the red icon starts blinking; pressing the button again the system goes back to the previous automatic mode.

G.3.7 Switch off

Press the  button to switch off the appliance.



WARNING

In case of accidental breaking of the glass-ceramic surface, immediately unplug the equipment

G.4 Choice of pots

The induction cooking system works with cookware whose bottom material reacts to the variable magnetic field produced by the components of the equipment.

The use of cookware with different characteristics therefore produces different effects.

It is therefore possible that the performances obtained will change according to the type of cookware used.

The manufacturer offers optional accessories (not included) that guarantee the highest performance.

The induction cooking system is equipped with a pot recognition system.

If the pot is removed from a turned on cooking area, that area switches to stand by automatically.

When the pot is put back on the zone, the zone comes on again.

- It is advisable to use pots specially designed for induction, and in particular multilayer-type pots.
- Use pots with bottom in iron, iron plate, enamelled iron, cast iron, special multilayer metals.
- This heating system does not work with unsuitable materials; these are: nickel-chromium s/steel, aluminium, copper, brass, glass, porcelain.
- Pots of diameter less than approx. **12 cm [4,72"]** are not recognized by the system; heating remains in stand-by.
- It is also advisable to use pots with maximum diameter **28 cm [11,02"]** in order to obtain maximum heating efficiency.
- Do not use empty pots or pans on the appliance as they can quickly reach very high temperatures.



CAUTION

To avoid compromising inductor functionality, never use pots with bottoms that are not perfectly flat: the temperature may not be measured correctly, damaging the appliance.

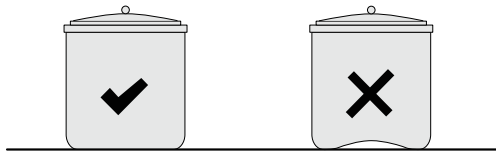

To avoid compromising inductor functionality of the Wok cooktop, never use pots with bottoms flat: the temperature may not be measured correctly, damaging the appliance.

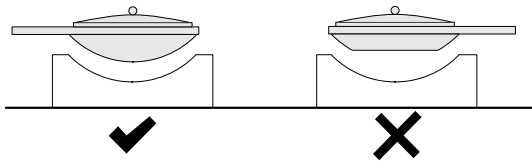

NOTE!

Use wok pots suggested by Electrolux Professional in order to obtain max performances of your appliance.
For further details please contact Electrolux Professional.

G.5 Cooking advice

- Never allow two or more pots to touch on the top when switched on.
- Induction has a very low inertia in transferring electric energy from the source to the food: if the energy value is changed the reaction on the food occurs immediately.
- Heating is very rapid.
- Shifting the pot on the glass-ceramic plate causes uneven conduction of heat on the bottom and therefore food sticking to a part of it: the pot must always remain in the middle of the cooking zone.
- Optimum even heating is achieved with pots properly centred on the circular serigraphy.
- When heating oil or fat, watch the pot constantly because these substances can quickly overheat and burn.
- Never place more than one pot on the same circular area.

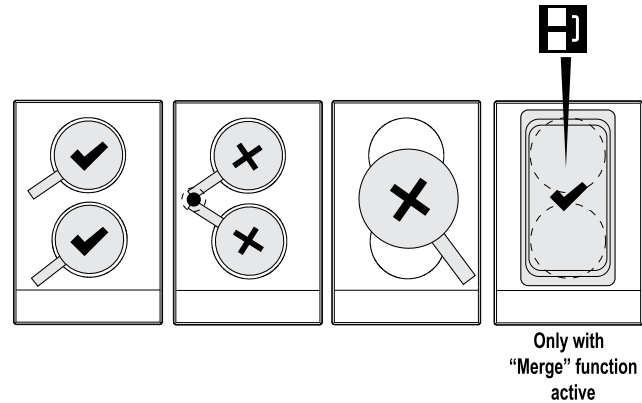
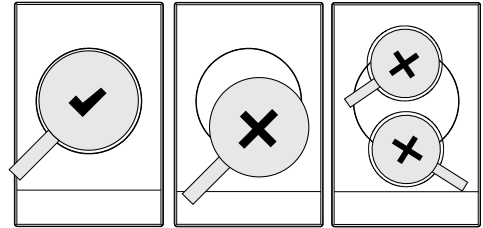

H APPLIANCE CLEANING AND MAINTENANCE



WARNING

Refer to *“WARNING and Safety Information”*

H.1 Ordinary maintenance

H.1.1 Care information

The following care operations have to be carried out by the owner and/or user of the appliance.



IMPORTANT

Problems resulting from poor or lack of care as hereinafter described will not be covered by the warranty.



WARNING

Before carrying out any cleaning or maintenance, disconnect the appliance from the power supply.

H.1.2 Cleaning the appliance and accessories

Before using the appliance, clean all the internal parts and accessories with lukewarm water and neutral soap or products that are over 90% biodegradable (in order to reduce the emission of pollutants into the environment), then rinse and dry thoroughly.



CAUTION

Do not use solvent-based detergents (e.g. trichloro-ethylene) or abrasive powders for cleaning.

H.1.3 Care of the unit – Daily

At the end of the day’s work, proceed as follows:

- Disconnect the main cable plug of the cooking appliances from the power supply.

Satin finish steel surfaces

- Clean all steel surfaces: dirt is easily removed when it has just formed.
- In case of encrusted grime, remove fat and other cooking residuals from steel surfaces when cool using lukewarm soapy water, with or without detergent, and a cloth or

sponge, wipe in the direction of the satin finish and rinse often, absolutely avoiding the use of cleaning products containing abrasive substances, steel wool, brushes or steel scrapers.



CAUTION

Rubbing in a circular motion combined with the particles of dirt on the cloth/sponge or metal objects could spoil or damage the steel: damaged surfaces become dirty more easily and are more subject to corrosion.

Restore the satin finish if necessary.

- Rinse with a wet cloth and dry thoroughly after cleaning.

Ceramic – glass surfaces

- Clean the glass-ceramic top using a paper serviette soaked in a specific detergent for glass; rinse the top, then dry with a clean and dry cloth.
- Do not clean the top when hot.

Induction surfaces

- It is forbidden to use aluminium foil in proximity of the induction zones: relevant damages shall not be covered by the manufacturer warranty.
- If noticing aluminium foils (even in small pieces), immediately remove to prevent damaging the induction device.



CAUTION

Make sure no water comes into contact with electrical components: water penetration can cause short circuiting and dissipation, tripping the appliance's protection devices.



IMPORTANT

Clean glass, metal and plastic parts only with non-aggressive detergents. Stop immediately using those products if detecting any visual or tactile characteristic change on surfaces and thoroughly rinse with water (examples: glass becoming mat/scratched/other, or plastic discoloring/melting/other, or metal showing rust/stains/ scratches). Carefully dry after rinsing

Griddles cooking plate

1. Only use stainless steel spatulas to place and remove food on the plate;
2. During cooking, clean using the scraper with blade edge for the smooth plate;
3. Do not use utensils that can damage the surface;
4. At the end of the day, with plate cold, clean with a sponge and carefully dry; vinegar can be used to remove any remaining marks, making sure to rinse the hot-plate afterwards;



IMPORTANT

For a perfect cleaning of the plate suggest to use the dedicated program "i" with the specific detergent DEGREASER C40 by Electrolux Professional (code 0S1841)

5. Do not use steel wool, abrasive powders or aggressive chemicals to clean the cooking surface.



NOTE!

Replace the blade of the scraper whenever it is not perfectly sharp.

Tanks and collection drawers (even several times a day)

- Remove any grease, oil, food residuals, etc., from trays, drawers and containers in general used for collection;
- Always clean these containers at the end of the day;

- While using the appliance, empty them when they are nearly full.

Surfaces blackened by heat (when necessary)

- Exposure to high temperatures can cause the formation of dark marks.
These do not constitute damage and can be removed by following the instructions given in the previous section.

At the end of the daily's cleaning, fit back in place the cooking modules, the side containers and all the parts.

H.1.4 Care of the unit – Monthly



IMPORTANT

Operations to be carried out only by trained personnel.

To avoid decreases in performance, Electrolux Professional suggest to clean the filters at the end of all month's work, proceed as described in *Care of the unit – Daily*.

Cleaning induction air filters

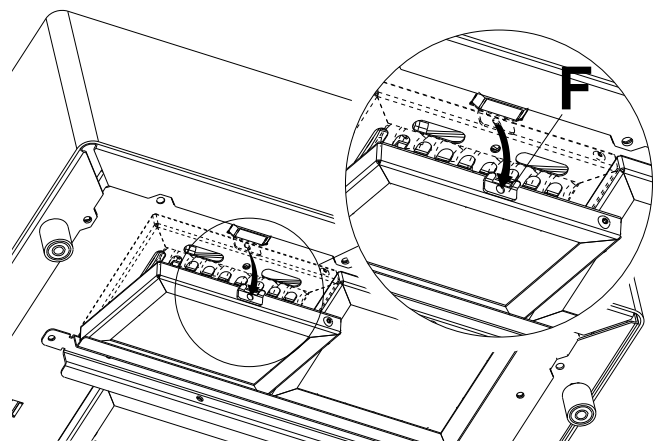

- For cleaning:
 - push the tab " F " in order to unlock the filters from their seats;
 - remove the dust from the filters and clean it properly;
 - If the filters are dirty with grease, wash them with degreasing soap, then rinse and dry;
 - at the end of the operation, refit the filters in their seats.



IMPORTANT

Filters can be placed in a dishwasher or cleaned with a hot water to remove all the grease or dirt.

H.1.5 Periods of non-use

If the appliance is not going to be used for some time, take the following precautions:

- close the water supply tap(s), if present;
- disconnect the power supply or remove the plug from the power socket, if present;
- clean the cabinet, going over all the stainless steel surfaces vigorously with a rag moistened with paraffin oil to create a protective film;
- leave the door or drawers, if present, open so that air can circulate inside, preventing the formation of unpleasant odours;
- for the electric heated models: switch the machine On at the minimum rate of heat for at least 45 minutes; this will allow moisture/humidity accumulated into the heating elements to evaporate without damaging the elements;
- periodically air the premises.

H.1.6 Internal parts (every 6 months)



IMPORTANT

Operations to be carried out only by specialised personnel.

- Check the condition of the internal parts.
- Remove any deposits of dirt inside the appliance.

- Check and clean the discharge system.



IMPORTANT

In particular conditions (e.g. intensive use of the appliance, salty environment, etc.) the above cleaning should be more frequent.

H.2 Repair and extraordinary maintenance



NOTE!

Repair and extraordinary maintenance have to be carried out by specialised authorised personnel, who can ask the manufacturer to supply a service manual.

H.3 Maintenance intervals

All the components requiring maintenance are accessible from the front or the rear panel of the appliance.

The inspection and maintenance intervals depend on the actual machine operation conditions and ambient conditions (presence of dust, damp, etc.), therefore precise time intervals cannot be given.

In any case, careful and periodical machine maintenance is advisable in order to minimise service interruptions.

To ensure constant machine efficiency, it is advisable to carry out the checks with the frequency given in the following table:



IMPORTANT

Machine maintenance, checking and overhaul operations must only be carried out by a specialised Technician or the Customer Care Service, provided with adequate personal protection equipment (safety shoes and gloves), tools and ancillary means;

Work on the electrical equipment must only be carried out by a specialised electrician or the Customer Care Service.

Maintenance, inspections, checks and cleaning	Frequency	Responsibility
Ordinary cleaning • general cleaning of machine and surrounding area.	Daily	Operator
Mechanical protection devices • check their condition and for any deformation, loosening or removed parts.	Yearly	Service
Control • check the mechanical part, for cracks or deformation, tightening of screws: check the readability and condition of words, stickers and symbols and restore if necessary.	Yearly	Service
Machine structure • tightening of main bolts (screws, fixing systems, etc.) of machine.	Yearly	Service
Safety signs • check the readability and condition of safety signs.	Yearly	Service
Electrical control panel • check the electrical components installed inside the electrical control panel. Check the wiring between the electrical panel and machine parts.	Yearly	Service
Electrical connection cable and plug • check the connection cable (replace if necessary) and plug.	Yearly	Service
Preventive maintenance • remove any deposits of dirt inside the appliance.	Yearly ¹	Service
Control • check the conditions of the internal parts.	Yearly ¹	Service
Control • check and clean the discharge system.	Yearly ¹	Service
General machine overhaul • check all components, electrical equipment, corrosion, pipes...	Every 10 years ²	Service

1. In particular conditions (e.g. intensive use of the appliance, salty environment, etc.) the preventive maintenance should be more frequent.

2. the machine is designed and built for a duration of about 10 years. After this period of time (from commissioning) the machine must undergo a general inspection and overhaul. Some examples of checks to be carried out are given below.

- Check for any oxidised electrical components or parts; if necessary, replace them and restore the initial conditions;
- Check the structure and welded joints in particular;
- Check and replace bolts and/or screws, also checking for any loose components;
- Check the electrical and electronic system;
- Check the functionality of safety devices;
- Check the general condition of protection devices and guards.



NOTE!

It is advisable to stipulate a preventive and scheduled maintenance contract with the Customer Care Service.

Decommissioning

- All scrapping operations must occur with the machine stopped and cold and the electrical power supply disconnected;
- Work on the electrical equipment must only be carried out by a qualified electrician, with the power supply disconnected;
- To carry out these operations it is necessary to use: overalls, safety shoes and gloves;
- During decommissioning and handling of the various parts, the minimum height from the floor must be maintained.

I TROUBLESHOOTING



IMPORTANT

The appliance is equipped with a self diagnostic system which displays error in case of malfunctioning detections.

I.1 Introduction

Certain faults may occur during normal use of the appliance. In some cases, faults can be eliminated easily and quickly by following the indication below.

The display, if present, always shows a warning message or alarm describing the occurring fault.

If the fault persists, contact the Customer Care Service:

1. disconnect the appliance from the main power supply;

2. switch off the safety circuit breaker ahead of the appliance;
3. close the gas and water tap(s), if they are present;
4. Remember to specify:
 - the type of fault
 - the appliance PNC (product number code)
 - the Ser. No. (appliance serial number).



IMPORTANT

The appliance PNC and serial number are essential for identifying the type of appliance and date of manufacture.

I.2 Warnings codes

Anomaly	Possible Cause	Remedy
E031	Firmware issue	Switch OFF/ON. If the error persists call service.
E311/E312	Supply voltage too high	Plug to a different socket. If the error persists, have the electrical system checked by an electrician.
E321/E322	Supply voltage too low	Plug to a different socket. If the error persists, have the electrical system checked by an electrician.
E401/E402	Temperature sensor fault	Switch off for 5 minutes then switch on again. If the error persists, call service. However, with double zone Frytop appliances it is possible to work with the non-affected zone.
E411/E412	Temperature sensor fault	Call service. However, with double zone Frytop appliances it is possible to work with the non-affected zone.
E421/E422	Cooking zone temperature too high	Switch off for 10 minutes then switch on again. However, with double zone Frytop appliances it is possible to work with the non-affected zone.
E431/E432	Temperature detection error	Switch OFF/ON. If the error persists call service. However, with double zone Frytop appliances it is possible to work with the non-affected zone.
E441/E442	Temperature sensor fault	Switch off for 5 minutes then switch on again. If the error persists, call service. However, with double zone Frytop appliances it is possible to work with the non-affected zone.
E501	Supply / Configuration	Call service.
E611/E612	Electronic overheating	Switch off for 5 minutes then switch on again. If the error persists, call service. However, with double zone Frytop appliances it is possible to work with the non-affected zone.
E651	Electronic fault	Switch OFF/ON. If the error persists call service.
E661	Firmware issue	Call service.
E701/E702	Electronic cooling stop	Switch off for 5 minutes then switch on again. If the error persists, call service. However, with double zone Frytop appliances it is possible to work with the non-affected zone.
E711/E712	Coil cooling stop	Switch off for 5 minutes then switch on again. If the error persists, call service. However, with double zone Frytop appliances it is possible to work with the non-affected zone.

E821/E822	Communication stop	Switch OFF/ON. If the error persists call service. However, with double zone Frytop appliances it is possible to work with the non-affected zone.
E831/E832	Communication stop	See E821/E822.
Poor cookingpower	Dirty filter	Clean air filters (see point 3 on the front page).
Touch board unreactive	Dirty hand/fingers/glove	Clean the interface with a paper towel, clean your hands and fingers and / or change the glove with a clean one and try again.
No heat	Pot/pan unsuitable for induction	Use pot/pan suitable for induction.

I.3 Inefficiencies detected during cooking

INEFFICIENCY	CAUSE	CORRECTIVE ACTION
Insufficient heating of cooking zone	Material of pot unsuitable	Use a pot made from appropriate material
	Over temperature	Switch off the appliance, cool down and check if the filters are dirty
No heating of cooking zone	Pot bottom less than 12 cm wide	Use a pot of suitable size
	Over temperature	Switch off the appliance, cool down and check if the filters are dirty
	Material of pot unsuitable	Use a pot made from appropriate material

J MACHINE DISPOSAL



WARNING

Refer to “*WARNING and Safety Information*”

J.1 Waste storage

At the end of the product's life-cycle, make sure it is not dispersed in the environment.

Depending on the model, the doors must be removed before scrapping the appliance.

SPECIAL waste materials can be stored temporarily while awaiting treatment for disposal and/or permanent storage. In any case, the current environmental protection laws in the user's country must be observed.

J.2 Procedure regarding appliance dismantling macro operations

Before disposing of the appliance, make sure to carefully check its physical condition, and in particular any parts of the structure that can give or break during scrapping.

The appliance's parts must be disposed of in a differentiated way, according to their different characteristics (e.g. metals, oils, greases, plastic, rubber, etc.).

Different regulations are in force in the various countries, therefore comply with the provisions of the laws and competent bodies in the country where scrapping takes place.

In general, the appliance must be taken to a specialised collection/ scrapping centre.

Dismantle the appliance, grouping the components according to their chemical characteristics, remembering that the compressor contains lubricant oil and refrigerant fluid which can be recycled, and that the refrigerator components are special waste assimilable with urban waste.



The symbol on the product indicates that this product should not be treated as domestic waste, but must be correctly disposed of in order to prevent any negative consequences for the environment and human health. For further information on the recycling of this product, contact the local dealer or agent, the Customer Care service or the local body responsible for waste disposal.



NOTE!

When scrapping the appliance, any marking, this manual and other documents concerning the appliance must be destroyed.

K ENCLOSED DOCUMENTS

- Set of test and inspection documents.
- Wiring diagram.
- Installation diagram.
- Declaration of Conformity

CE